

TOMTAR DH / TOMTAR DS

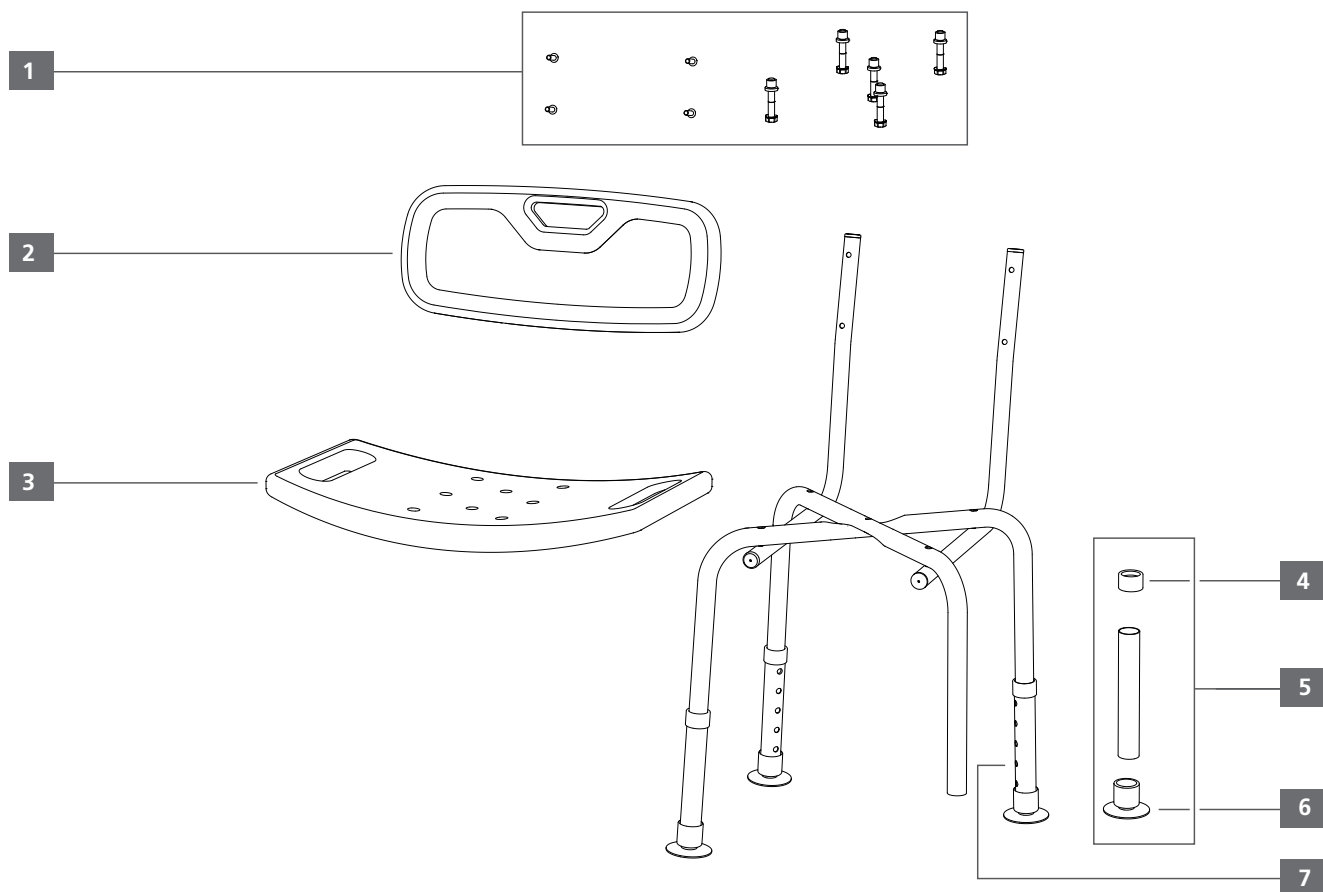

Bath & WC

Product name	Product design	Item no.	Version
TOMTAR DH	Shower stool	411300	V 1.0
TOMTAR DS	Shower chair	411301	2022-11



Position	QTY./ Product	TOMTAR DH	TOMTAR DS	Item no.	Description	QTY. supply
1	1		■	411303	Screw set, seat/backrest	set
2	1		■	411304	Backrest	pc.
3	1	■	■	411302	Seat	pc.
4	1	■	■	411305	Guide bushing, telescopic leg (set = 4 pcs.)	set
5	1	■	■	411306	Telescopic leg	pc.
6	1	■	■	411307	Rubber feet (set = 4 pcs.)	set
7	4	■	■	411308	Spring push button	pc.