

TOMTAR®

Santilo

Bath board

User manual version: 2.0.0 EN

EN



Record of product identification data

We recommend that you write down your product identification data (found on nameplate) below, so that you have these on hand should you require any further information about your product.

(See "Product labelling" section)

TYP Type / model	
REF Item No. / REF:	
UDI Serial number (21):	
 Date of manufacture:	
Other information/notes:	

Many thanks for choosing a bath board made by DIETZ.

This product is a medical aid. In order to use it properly and avoid possible risks due to unintended use, you must become thoroughly familiar with its operation.

Read this user manual carefully before you begin using your product. It contains important instructions that will enable you to fully take advantage of the technical benefits. In addition, you will receive information that will aid with maintaining operational safety and the preservation of your investment in your product.

If you have any questions or require additional

information, please contact the specialist retailer which supplied the product to you.

You will always find the latest information about your product on our website. For information or queries concerning product safety and on recalls, please contact DIETZ in writing or by telephone. You will find our contact information on the back of this user manual.



NOTE

A large-print version of the user manual is available for visually impaired persons at **www.dietz-group.de** in PDF format.

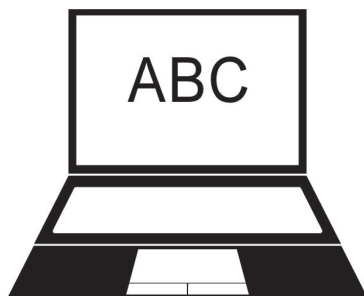

1 Important information		5 Technical data	
1.1 General information	5	5.1 DIETZ's measurement system.	11
1.2 Intended purpose	5	5.2 Dimensions and technical specifications.	12
1.3 Indications	5	5.3 Product tests.	12
1.4 Contraindications	5	5.4 Materials	12
1.5 Symbols	6	5.5 Product labelling.	13
2 Product description		6 Safety instructions	
2.1 Scope of delivery	7	6.1 Safety instructions.	14
2.2 Exemplary representation	7	7 Care and maintenance	
2.3 Accessories	7	7.1 Servicing/maintenance.	15
3 Commissioning the product		7.2 Maintenance schedule	16
3.1 Assembly instructions	8	7.3 Cleaning	17
3.2 Tools	8	7.4 Disinfection.	17
3.3 Mounting the bath board	8	7.5 Disposal	17
4 Using the product		7.6 Forwarding/Reusing.	18
4.1 Adjusting the bath board	9	7.7 Storage	18
4.2 Getting in and out.	9	8 Manufacturer's declarations	
4.3 Accessories and add-ons from external suppliers	10	8.1 Warranty	19
4.4 Transport.	10	8.2 Lifetime.	19
		8.3 Liability.	19

1.1 GENERAL INFORMATION

This user manual is included in the scope of delivery. The user should keep this manual on hand at all times and it must remain with the product if the product is passed on to a third party. We reserve the right to make changes to the versions shown in this user manual as a result of further technical development. Reprints,

translations and reproductions of this manual in any form, in whole or in part, require the written approval of DIETZ GmbH. The copyright is owned by the manufacturer. You can obtain the latest version of the user manual by contacting DIETZ GmbH. Read the user manual before assembling and using the product.

1.2 INTENDED PURPOSE

The product is designed to make it easier for people with reduced mobility to clean themselves (shower) and dry themselves while sitting at the height of the bathtub rim. It is designed for a maximum user weight of 150 kg.

The product is not suitable for persons who are

smaller than 146 cm or weigh less than 40 kg (BMI < 17) and must not be used by children. The product is not suitable for use as permanent seating. It is not to be used to transport persons or loads.

1.3 INDICATIONS

The use of the product is indicated for:

- ▼ Standing and inability to stand
- ▼ Standing and instability
- ▼ Loss of / defective / deformed limbs

1.4 CONTRAINDICATIONS

The product is unsuitable in the case of:

- ▼ Perception disorders
- ▼ Severe disequilibrium
- ▼ Inability to sit
- ▼ A body weight exceeding 150 kg

1.5 SYMBOLS

These symbols indicate passages of text that are helpful for using and operating the product in everyday life.



WARNING

It is mandatory to observe and comply with warnings. They draw your attention to the fact that failure to comply with them may result in injury and/or damage to the product or the environment. _____



NOTE

Tips and advice which make using the various functions easier. _____

2.1 SCOPE OF DELIVERY

The product is wrapped in protective film at the factory and is supplied in a cardboard box.

Upon receipt of the goods, please immediately check to make sure that the contents are complete and undamaged. If the contents are noticeably damaged, inform the freight company immediately.

Santillo scope of delivery:

- ▼ 1 bath board
- ▼ 1 grip handle incl. 2 plastic screws
- ▼ 4 clamping pins incl. 4 plastic screws
- ▼ 1 user manual



WARNING

Risk of poisoning: When burnt, packaging films can release toxic gases.

Risk of suffocation: Keep the plastic bags out of the reach of children.

2.2 EXEMPLARY REPRESENTATION

1. Grip handle
2. Clamping pins
3. Bath board



Abb. 1

2.3 ACCESSORIES

No accessories are provided for the product.

3.1 ASSEMBLY INSTRUCTIONS

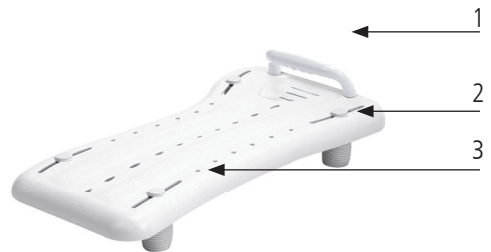
The assembly and the functional check are to be performed by the specialist dealer. The dealer's technician adapts the product to the respective user.



NOTE

Read the user manual before assembling and using the product.

3.2 TOOLS:

Assembly can be completed without tools

3.3 Mounting the bath board

1. Lift the product out of the packaging using both hands and remove the plastic bag.
2. Mount the grip handle as such, that the handle on the top of the board points towards the bath board. The plastic thread is pushed in against it from below. Screw the grip handle firmly in place with the two threads (Fig. 2, 1).
3. For mounting the clamping pins, insert a plastic thread into each sliding slot from above. The clamping pins are placed on the threads from the underside and screwed tightly together (Fig.2, 2).



WARNING

Risk of trapping: Take care of your hands/fingers during the entire assembly.



Abb. 2

4.1 Adjusting the bath board

The bath board can be placed on the edge of standard bath tubs and fixed in place. This adjustment is usually carried out by a specialist dealer. Proceed as follows if you are performing the adjustment/fixing yourself.

1. Release the clamping pins on the underside of the bath board (do not unscrew completely) (Fig. 3, 1).
2. Place the bath board in the centre of the bath rim and ensure that the anti-slip rubber pads rest on the right and left sides of the bath rim.
3. Push the clamping pins uniformly against the inner rim of the tub (Fig. 3, 2) and tighten them firmly.

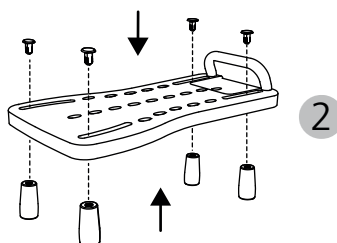
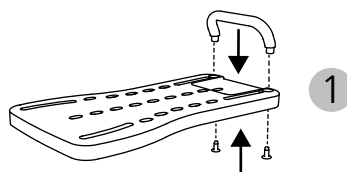

WARNING

Risk of trapping: When adjusting the clamping pins, watch your hands/fingers.

Tipping danger: Worn or damaged rubber pads should be immediately replaced.

Risk of accident: Ensure that the product is correctly adjusted to the width of the tub and that the anti-slip rubber pads rest on the right and left sides of the tub.

Danger of slipping: The rubber pads and the rim of the tub have to be kept free of grease, soap and shower gel in and around the pads. —



Abb. 3

4.2 Getting in and out

1. Lay the bath board on the rim of the bath so that the grip handle is opposite the side where you enter the bath.
2. When getting in/out, sit on the bath board from the side and turn into the bath. Make sure you are in the centre of the board. If necessary, have someone help support you.

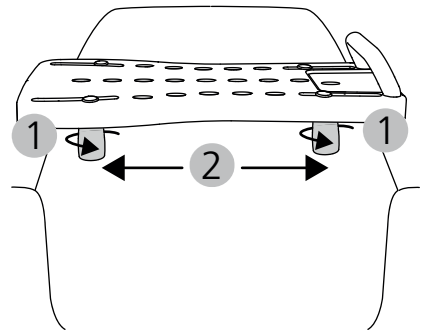

WARNING

Tipping danger: Please note that body movements shift the centre of gravity and can increase the risk of the product tipping over.

Tipping danger: Do not stand with your feet on the seat. —

4.3 ACCESSORIES AND ADD-ONS FROM EXTERNAL SUPPLIERS

There are no accessories available from DIETZ for this product. Generally, only original accessories from DIETZ GmbH are permitted to be used. If third-party products are installed on the product, responsibility for the safety of the product passes to the person who installs the accessories or carries out the installation. A new declaration of the compliance of the combination of accessories or add-on and product is then to be made by the person who attaches it. The compliance declared by DIETZ according to MDR 2017/745, Annex I-III shall expire.



WARNING

Safety hazard: Should add-ons or accessories that are not sold by DIETZ be used, the safety of the product cannot be guaranteed.

If accessories or add-ons are added to the product, then the safety instructions in the operating instructions for the accessories or add-ons must be observed. _____

4.4 TRANSPORT

The product is not a device for frequent transport. Should it be necessary to transport the product, we recommend disassembling it according to _____ above _____ assembly instructions in reverse. The product should be packed such that it is in a stable position and there is no danger of sudden and dangerous movements in the means of transport.

5.1 DIETZ'S MEASUREMENT SYSTEM

The dimensions given here refer to the standard configuration of the product.



NOTE

All dimensions taken on textile parts (e.g. back upholstery) are to be understood with a tolerance of ± 10 cm.



Abb. 4

5.2 SPECIFICATIONS

Technical specifications			Santilo	
	Colour	mm	white	white
a	Total width	mm	350	350
b	Total length	mm	690	740
c	Total height	mm	160	160
	Seat surface (W × D)	mm	510 × 240	590 × 240
	Bath tub adjustment dimension	mm	300 - 530	380 - 650
	Ambient operation temperature		10 C° to +40 C°	
	Ambient storage conditions		0°C to 45°C // 20% to 75% relative humidity	
	Total weight	kg	2.2	2.7
	Maximum user weight ¹	kg	150	150

¹ Maximum user weight including load/The weight of the load reduces the maximum user weight

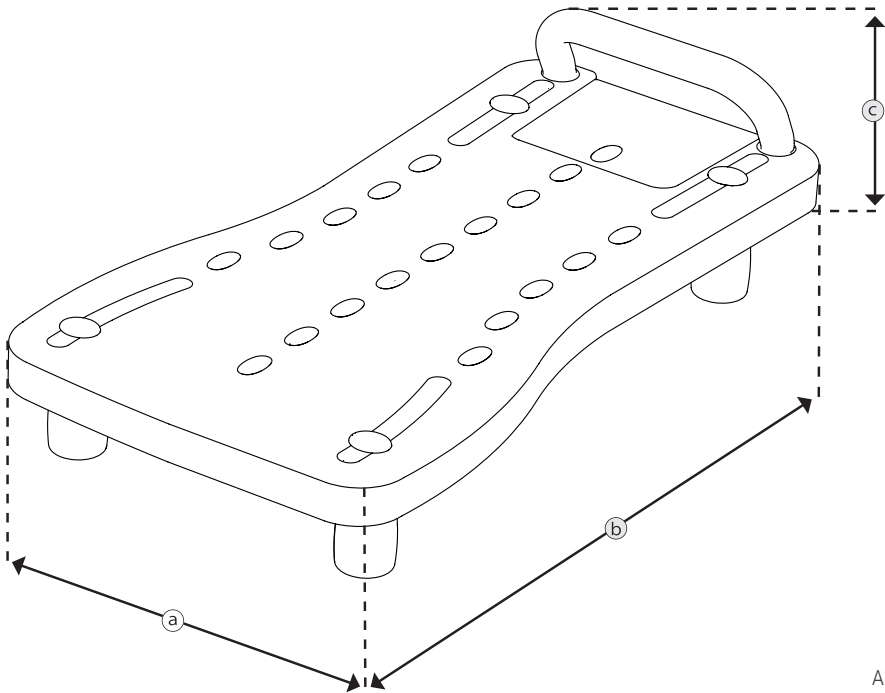
5.3 PRODUCT TESTS

DIN EN 12182	Tested in accordance with the requirements of technical aids for disabled people
ISO 17966	Tested according to the requirements and test methods for personal hygiene aids
ISO 10993-5	Tested for toxicity in the material
Test dummy weight	150 kg

5.4 MATERIALS

Bath board	Polypropylene + 20% MF
Grip handle	Polypropylene + 20% MF
Clamping pins	Polypropylene + 20% MF (inside) / thermoplastic rubber (outside)
Plastic screws	Acrylonitrile butadiene styrene (ABS)

Note: All metals used are corrosion-resistant

5.5 PRODUCT LABELLING

Type plates and warning signs on the product must remain legible. Immediately replace illegible or missing stickers. The serial number sticker is very important for identifying the product, it is placed on the product label, which is placed below the seat. It must not be removed.



Abb. 5

TOMTAR®	Trademark
TYP	TYPE/Model
REF	REF = Item number
UDI	UDI = Unique Device Identifier (01) UDI-DI / GTIN (10) Order number (21) Serial number
	Manufacturer/manufacturer's trademark/contact address
	Maximum load capacity/load incl. payload
	Date of manufacture
	The product is only approved for indoor use
	Follow the user manual
	Caution: Note the safety information in the user manual!
MD	Medical Device
CE	CE marking MDR 2017/745, Annex I-III

6.1 SAFETY INSTRUCTIONS

When using the product, always observe the following safety instructions to prevent falls, hazardous situations and damage to the product:

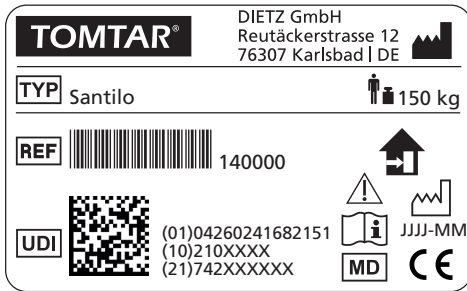
- ▼ The product is only to be used indoors in the bathtub.
- ▼ Do not use the product as a climbing aid or stand on it.
- ▼ Do not load the product unevenly.
- ▼ There is a risk of slipping when sitting down and standing up in wet bathtubs, particularly when shower additives (e.g. soap or shower gel) are used.
- ▼ Check the product for damage before each use. Do not use a damaged product.
- ▼ Check the adjustment to the bathtub and the tight fit of the screw connections after each disassembly and reassembly.
- ▼ If your mobility is severely limited, use the product with the aid of an accompanying person.
- ▼ The surface of the product may become hot due to hot water or exposure to sunlight. Risk of burns!
- ▼ Any severe incidents associated with the product must be reported to the manufacturer and responsible authority.

7.1 SERVICING/MAINTENANCE

We recommend performing the inspections listed in the maintenance schedule at regular intervals to ensure that the product is always safe to use.

Failure to ensure care and maintenance or insufficient care and maintenance of the product leads to a restriction of liability. The maintenance schedule does not provide any information on the amount of work that will actually need to be performed on the product.



NOTE

As the user, you will be the first to notice any damage. If you notice a fault as described in the maintenance schedule or further defects and functional impairments, contact an authorised specialist dealer immediately. _____



WARNING

Repairs on the product must only be performed by specialist shops using DIETZ original spare parts to maintain the operational safety of the product. The relevant spare parts catalogue can be found on our website in the information of the product in question. _____



NOTE





The inspections and measures stipulated in the maintenance schedule must be performed by the user or assistant if not otherwise stated. _____



NOTE FOR SPECIALIST DEALERS:

If the user reports abnormalities on the product, please check all the inspection points listed in the maintenance schedule. The checks must also be performed before putting the product back into operation and after longer storage periods (> 4 months). _____

7.2 MAINTENANCE SCHEDULE

What	Description	Monthly	
		Before use	
Check bath board for damages	 Check the board for deformations, cracks or breaks. The product must no longer be used if such damage is found. Immediately contact your specialist dealer for repairs.	x	
Grip handle Check for tight fit	<ul style="list-style-type: none"> • Check the grip handle for tight fit. The screws may have to be retightened.  A defective grip handle must be replaced immediately. Immediately contact your specialist dealer for repairs.	x	
Clamping pins Check for tight fit	<ul style="list-style-type: none"> • Check the clamping pins for tight fit and retighten the screws if necessary.  Defective clamping pins must be replaced immediately. Immediately contact your specialist dealer for repairs.	x	
Check rubber pads for correct placement and for damage	<ul style="list-style-type: none"> • Check that the rubber pads are resting on the right and left sides of the tub rim. 	x	
	<ul style="list-style-type: none"> • Check the rubber pads for damages  Defective rubber pads must be replaced immediately. Immediately contact your specialist dealer for repairs.		x
Visual inspection , check for loose parts, breaks or other damage	 If damage of this type is found, discontinue use of the product, as safe use can no longer be guaranteed. Please contact your specialist dealer		x
Entire product check for dirt	<ul style="list-style-type: none"> • Product parts that are in direct contact with the skin must be cleaned or disinfected after every use. 	x	
	<ul style="list-style-type: none"> • The entire product must be cleaned/disinfected depending on the degree of soiling, but at least monthly (see "Cleaning and disinfection" Chapter). 		x

7.3 CLEANING

To clean the product, use lukewarm water mixed with a mild detergent (without solvents and with a pH value of 5-9). After cleaning, wipe with clear water and then dry the product with a cloth.



WARNING

Material damages: Do not use high-pressure cleaners, strong, corrosive chemicals or scouring agents for cleaning purposes.

Risk of corrosion: To avoid corrosion, ensure that all materials dry completely after cleaning. _

7.4 DISINFECTION

Wipe down or spray all components thoroughly with commercially available surface disinfectant. Take particular care to disinfect surfaces that come into frequent contact with hands/skin, such as the seat surface, backrest and armrests. Please only use the following disinfectants; use of other chemicals might damage the product.

- ▼ Aldehyde-free disinfectants based on alcohol (max. 70% propylalcohol)



WARNING

Material damages: During disinfection, observe the use and application instructions issued by the cleaning agent / disinfectant manufacturer.

Risk of infection: The product must be disinfected before each user change. _____

7.5 DISPOSAL

If you no longer need the product, please contact your specialist dealer. They will then pick up the product and either dispose of it properly or make further use of it. Otherwise, please take the product to your local waste disposal facility.

7.6 FORWARDING/REUSING

Your product is suitable for transfer to/reuse by others. The number of times it can be reused depends on the material wear conditions and the functional capabilities of the respective product. When handing over the product or re-using it, please remember to hand over to the new user or the specialist dealer all the technical documents necessary for safe handling.

Before being re-used, the product must be cleaned and disinfected, and must be checked for damage and approved by a specialist retailer. To do this, all test points listed in the maintenance plan must be checked on the product.

7.7 STORAGE

To store the product, ensure that it is stored in a dry place protected against direct, strong sunlight and at a temperature of 0°C to +45°C. When in storage, secure the product against unwanted movement or toppling over.

After longer periods of storage (> 4 months), please check all the inspection points on the product listed in the maintenance schedule before reusing/redeploying the product.



WARNING

Material damages: Do not store the product near a heat source and do not place any objects on the product during storage. _____

8.1 WARRANTY

Warranty services refer to all product defects which are verifiably attributable to material or manufacturing flaws. The warranty period is 24 months as of receipt of notification of readiness for shipping, but following delivery at the latest.

Damage which has occurred due to natural wear, intent, and negligent or improper operation or usage is excluded from the warranty obligation. This also applies to the use of unsuitable care products, lubricating oils or greases.

8.2 LIFETIME

The expected product service life is five years when used daily and if used as intended. This assumes compliance with the maintenance and

safety specifications stipulated in this manual. The indicated life span does not constitute additional guarantee.

8.3 LIABILITY

DIETZ GmbH only bears liability if the products are used under the specified conditions and for the specified purposes. We recommend that the products be handled appropriately and cared for according to the instructions. DIETZ GmbH is not liable for damage caused by components and spare parts that have not been approved by DIETZ GmbH. Repairs must only be carried out by authorised specialist retailers or by the manufacturer itself.

TOMTAR®



Product group: Bath board

Product: Santillo

User manual version: 2.0.0 EN

Last update: 2021-03 (RPO)

DIETZ GmbH

Reutäckerstrasse 12

76307 Karlsbad

Germany

Tel.: +49 7248.9186-0

Fax: +49 7248.9186-86

info@dietz-reha.de

www.dietz-group.de

TOMTAR is a registered trademark belonging to DIETZ GmbH.

TOMTAR products are sold by DIETZ GmbH.

Misprints, errors, price and product changes reserved.

© DIETZ GmbH, Karlsbad

Reproduction, either in part or in whole, only with written permission of DIETZ GmbH, Karlsbad.