

Order form

Manual XXL-Wheelchair | tauron|rsi

Status 2024-04 / Version 5.1



tauron|rsi[®]

Shaping mobility.

Completing the form on paper

Simply print out the order form, check the relevant component boxes to configure the product, sign the form and send it to us at:

Fax: +49 7248.9186 - 86

Completing the form on a computer or tablet

If you open the document in Acrobat, a menu bar highlighted in colour appears at the top edge.

If the option „Highlight Existing Fields“ is activated, all writeable and selectable fields will be displayed.

- Circular selection fields indicate that a selection has to be made within the chosen selection.
- Circular filled selection fields indicate that these options are included in the standard.
- Square selection fields are not subject to any conditions and are freely selectable and deselectable.

Save the order form locally on your computer under a free selectable name and send it to our customer service via email / fax :

info@dietz-group.com

fax: +49 7248.9186 - 86

Printing errors, mistakes and changes to prices and products reserved. © DIETZ GmbH REHA-PRODUKTE, Karlsbad
This catalogue may be reprinted, in part or in full, only subject to the prior written consent of DIETZ GmbH, Karlsbad.

You can find our general terms and conditions at: <https://shop.dietz-group.de/allgemeine-geschaeftsbedingungen-agb>

Order form tauro|rsi

Details to your order:

Healthcare supply store		
Customer no.		
Order	Offer based on selling price	Offer based on purchase price
Name of patient/commission		
Delivery address		
Comments		
Company stamp		
Date, signature		



tauron|rsi®

	tauron rsi
Colours	Frame aluminium anodised: Luna Grey
Seat width front selectable (mm)	600 / 650 / 700 / 750
Seat width back settable (mm)	0 bis - 100
Seat depth selectable (mm)	430 / 360 (short side frame) 480 / 390 (long side frame)
Seat height settable (mm)	390 / 430 / 470 (without seating cushion)
Push Handles position settable (°)	360° in 45° steps
Overall width (mm)	Seat width front + 190
Overall height (mm)	1030
Overall length with legrests (mm)	1040 incl. Standard-Legrests (short side frame) 1090 incl. Standard-Legrests (long side frame)
Overall length without legrests (mm)	790 (short side frame) 840 (long side frame)
Dimension folded (mm)	330
Pivot width min. (mm)	1270 (short side frame) 1430 (long side frame)
Minimum turning radius (mm)	890
Armrests height (mm)	300 (without seating cushion)
Armrests width (mm)	50
Armrest length (mm)	250
Lower leg length settable (mm)	390 - 460
Driving wheels (Diameter inch)	24" (Rim, Grasp and wheel hub: Aluminium black anodised)
Castor wheels (Diameter mm / inch)	150 / 200 // 6 / 8
Maximum Capacity (kg)	250
Overall weight (kg)	28

Product details Basic configuration

- Frame, seat frame and side panels made of aluminium
- Parking brake
- Adjustable padded back rest (Velcro®)
- Comfortably padded back rest
- Adjustable seat height
- Seat width adjustable at the rear by positioning the arm rests max. -100 mm
- Push bar adjustable in 45° increments
- Adjustable wheelbase
- Abduction frame + abduction side panels
- Polyurethane arm rest depth adjustable by 30 mm
- Stabilisers to prevent tipping included
- Padded side panels included
- Padded seat included
- Load up to 300 kg for seat height 430/470 mm possible. Price on request

Price Basic configuration (EUR)

from 4.790,00

Obesity typology normally distinguishes between A body types and B body types

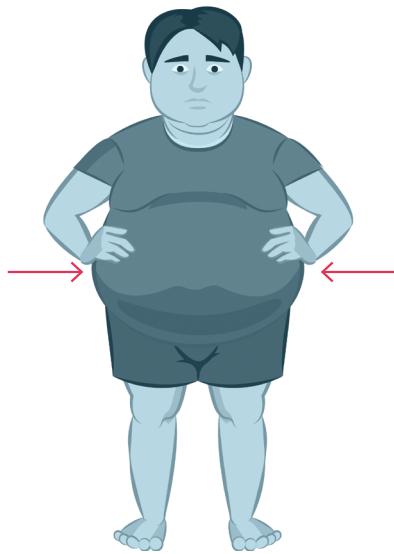

Type A

Body type A

- Predominantly male.
- Accumulates fat primarily in the abdominal region, usually beneath the abdominal muscles.
- Normally forces the person to sit with the legs very far apart. It is also usually more comfortable to lean back in order to ease the burden on the abdominal region.

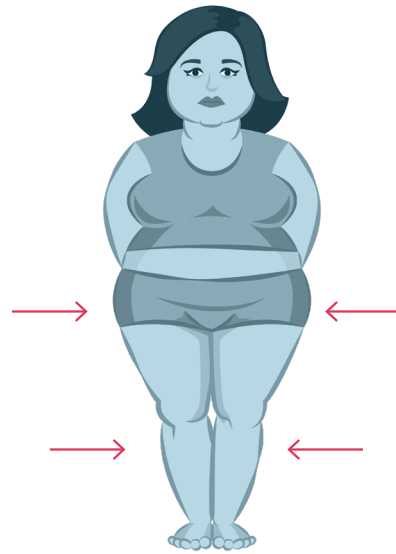

Type B

Body type B

- Predominantly female.
- Accumulates fat primarily around the bottom and on the upper and lower thighs, usually above the muscles.
- Bodily volume in the bottom region prevents a comfortable sitting posture

The abduction frame **1** and the abduction side panels **2** on the tauron|rsi can adjust the rear seat width very flexibly to accommodate.

The tauron|rsi is designed specially to meet the ergonomic needs of caring for obese patients. The abduction frame and abduction side panels optimize the seating position from an ergonomic perspective, allowing obese patients in particular to sit more comfortably.

At the back, the seat width can be adjusted simply by swinging the side panels outwards or inwards. The tauron|rsi thus provides ongoing support in the course of an illness, as it can easily be adapted to changes in the patient's physical condition.

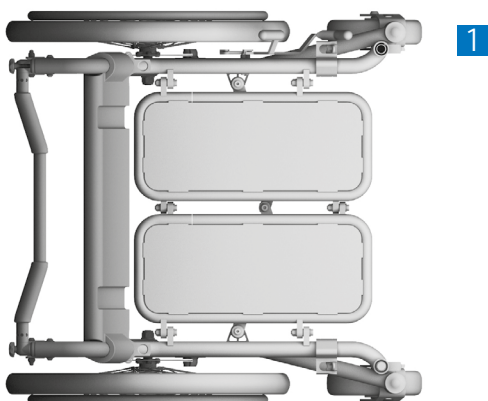

1



2

The position of the abduction side panels on the tauron|rsi can also be reversed, creating even more variable adjustment options in an instant.

Type A) The standard position facilitates an abducted leg position.

Type B) The reversed position leaves more room for the upper thighs.



Type A



Type B

Order form tauron|rsi

Key dimensions and specifications

Together with the height and weight of the user, these are the key dimensions allowing us to align the wheelchair perfectly to the needs of the user.

Type A

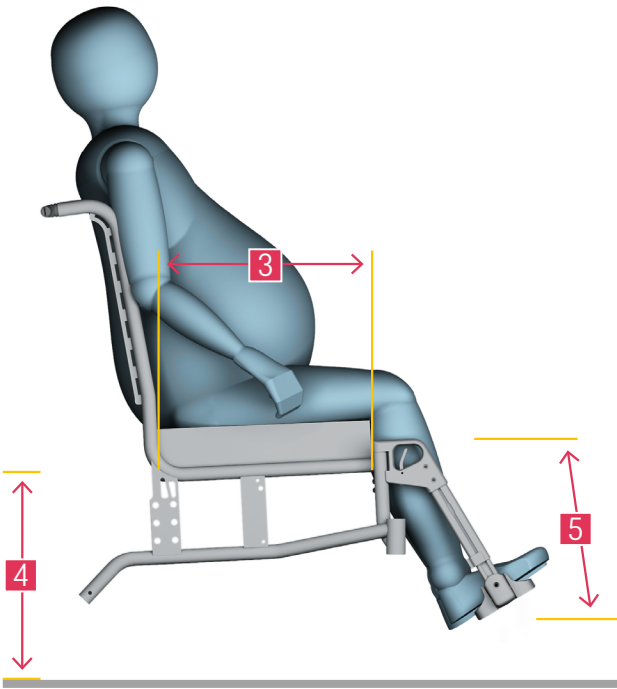

Type B

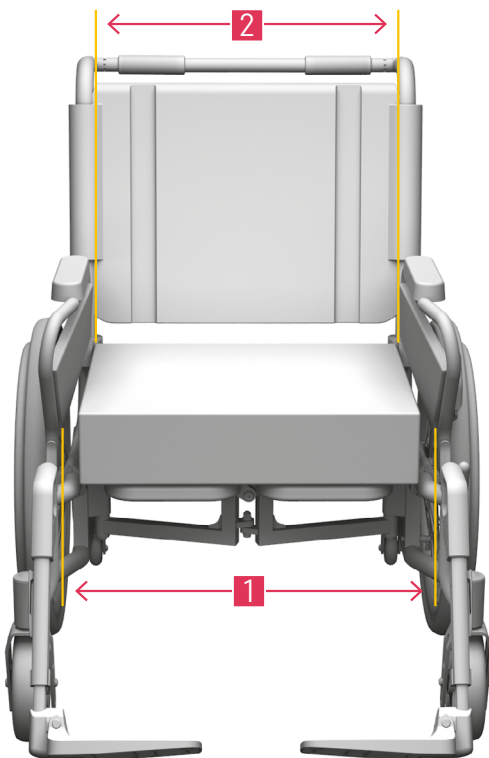
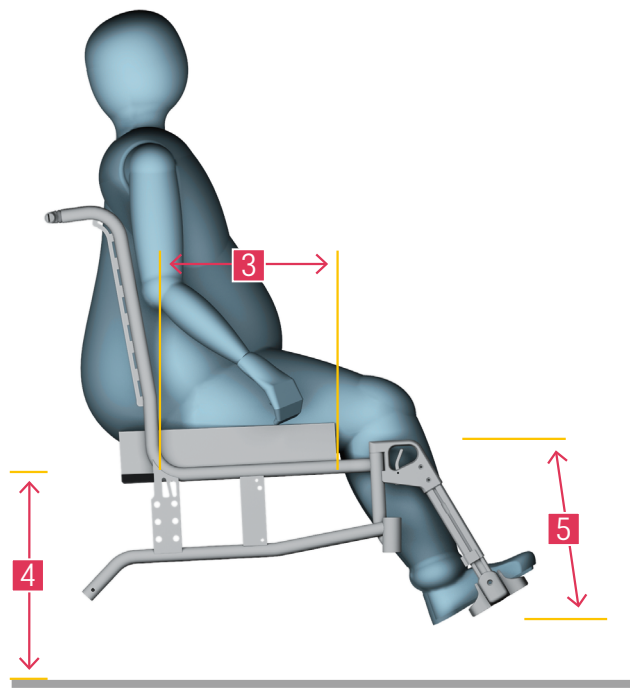

		DIMENSIONS
	Age of customer	
	Height (cm)	
	Weight (kg)	
1	Seat width front (cm)	
2	Seat width back (cm)	
3	Seat depth (cm) Front edge backrest to front edge seat plate	
4	Seat height* (cm) Length of lower leg + sufficient clearance be- tween foot plate and ground (at least 4 cm)	
5	Lower leg length (cm) For the correct height of the foot plate	

* Specification without seat cushion

Order form tauro|rsi

Seat width / Seat depth

SELECT THE RIGHT SEAT WIDTH

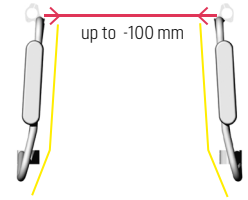
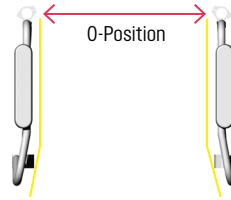
Adjustable seat widthSeat depth back:
max. -100 mmSeat depth in the front
selectable

		Seat width (mm)	front	600	650	700	750
			back	500 - 600	550 - 650	600 - 700	650 - 750
Seat depth (mm)	360	Item no.					
	430		713008	713009	713010	713011	
	390	Item no.					
	480		713012	713013	713014	713015	
		EUR*	4.590,00	4.790,00	4.990,00	5.190,00	

Seat depth is measured from the front edge of the backrest to the front edge of the seat plate.

Seat depth standard:

430 mm short / 480 mm long side frames

Seat depth with 180 ° rotated seat plate

360 mm short / 390 mm long side frame

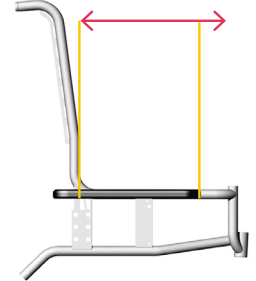
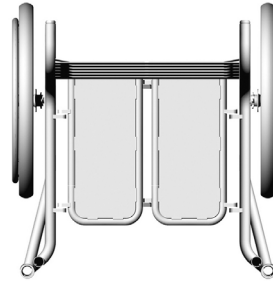
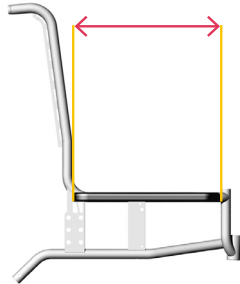

Order form tauro|rsi

Selection	Item no.	Description	Comment	EUR*
-----------	----------	-------------	---------	------

SELECT SEAT HEIGHT

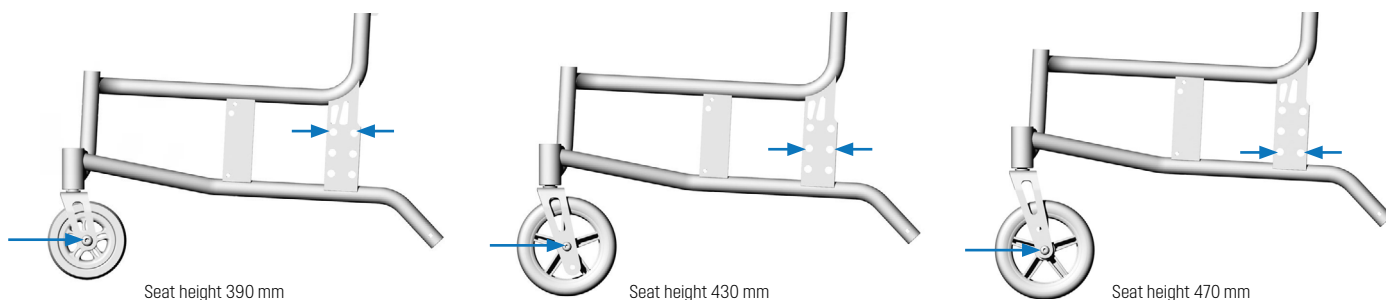

713101	Seat height 390 mm, Castor 150 mm / 6"	mounted	00,00
713102	Seat height 430 mm, Castor 200 mm / 8"	mounted	00,00
713103	Seat height 470 mm, Castor 200 mm / 8"	mounted	00,00

POSITIONING OF THE DRIVING WHEEL

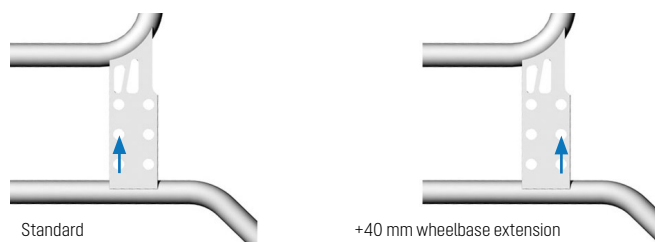

713201	+40 mm wheelbase extension for seat depth 390 mm (long side frame)	mounted	00,00
713202	+40 mm wheelbase extension for seat depth 480 mm (long side frame)	mounted	00,00

not in connection with short side frame!

POSITIONING PUSH HANDLE

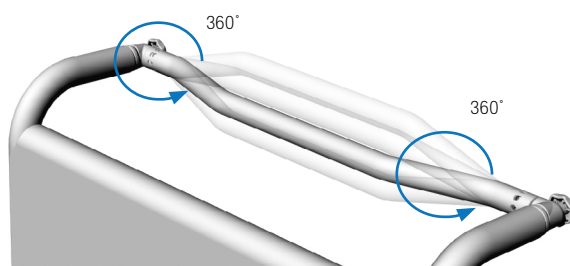

Standard	Push handle 360°	mounted	00,00
----------	------------------	---------	-------

Standard 0° = 30 mm to the front, in every position adjustable (in 45° steps) and swing away

BRAKE FOR ATTENDANT PERSON

713401	Disc brake for attendant, operation left	mounted	261,60
713402	Disc brake for attendant, operation right	mounted	261,60

Not available in combination with Solo+ / V-Max+

Order form tauron|rsi

Selection	Item no.	Description	Comment	EUR*
-----------	----------	-------------	---------	------

OPTIONS LEGRESTS

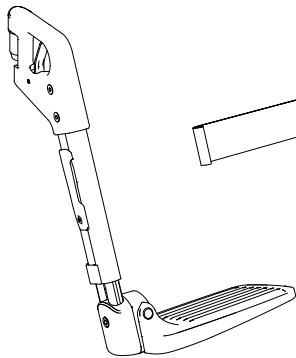

Legrest Standard

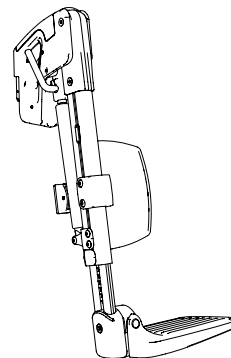
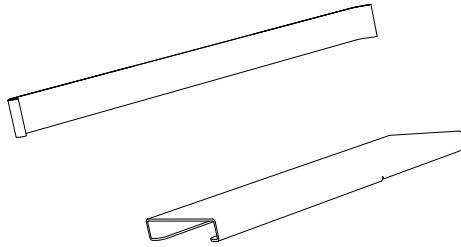

Legrest angle adjustable

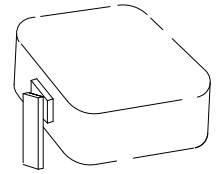

Amputation support

Standard	Legrest incl. footplate, swing-away and angle adjustable footplate, calf strap	left	0,00
Standard	Legrest incl. footplate, swing-away and angle adjustable footplate, calf strap	right	0,00
713511	Knee cushion (set), not in combination with legrest angle adjustable	left / right	105,50
713503	Legrest, angle adjustable, swing-away and angle adjustable footplates	left	415,60
713505	Amputation support	left	328,40
713519	Knee cushion for legrest angle adjustable	left	75,30
713504	Legrest, angle adjustable, swing-away and angle adjustable footplates	right	415,60
713506	Amputation support	right	328,40
713518	Knee cushion for legrest angle adjustable	right	75,30

SEAT CUSHION

713631	Heavy duty cushion standard measurement; black incl. incontinence cover, height 120 mm		235,80
713632	Heavy duty cushion 50 mm longer, black, incl. incontinence cover, height 120 mm		235,80

A longer Seat Cushion includes an additional support in the area of buttocks, especially in combination with a deeper seat depth.

ANTI-DECUBITUS CUSHION

420221	Vicair Xxtra O2 cushion, 60 cm x 45 cm x 10 cm		1.113,00
420222	Vicair Xxtra O2 cushion, 60 cm x 50 cm x 10 cm		1.113,00
420223	Vicair Xxtra O2 cushion, 65 cm x 45 cm x 10 cm		1.113,00
420224	Vicair Xxtra O2 cushion, 65 cm x 50 cm x 10 cm		1.113,00
420225	Vicair Xxtra O2 cushion, 70 cm x 45 cm x 10 cm		1.591,00
420226	Vicair Xxtra O2 cushion, 70 cm x 50 cm x 10 cm		1.591,00
420227	Vicair Xxtra O2 cushion, 75 cm x 45 cm x 10 cm		1.591,00
420228	Vicair Xxtra O2 cushion, 75 cm x 50 cm x 10 cm		1.591,00

Deviations from the wheelchair dimensions of -2 cm are negligible

Order form tauron|rsi

Selection	Item no.	Description	Comment	EUR*
-----------	----------	-------------	---------	------

HEADREST

713702	Headrest, 4-settings adjustable (angle, height, depth, lateral), PU chusion			380,00
--------	---	--	--	--------

AUXILIARY DRIVE

346071	Solo+ black series, wheel hub drive, incl. lithium-ion battery			7.950,00
346058	Braket Solo+ black series			249,00

Can only be combined with seat height 430/470 mm (heavy duty wheel 200 mm / 8")

346061	Attendant control SmartControl, sliding and operating handle			619,00
346062	Holder attendant control SmartControl			144,00

PUSHING AND BRAKING AID

346063	V-Max+ pushing and braking aid, 12V/22AH, up to 300kg			6.850,00
346059	Braket V-Max+			249,00

Can only be combined with seat height 430/470 mm (heavy duty wheel 200 mm / 8")

VARIOUS OPTIONS

Standard	Anti-Tip-Wheels, left / right	mounted		0,00
----------	-------------------------------	---------	--	------

Standard	Tires PU, puncture proof, width 43 mm	mounted		0,00
713803	Tires pneumatic, Schwalbe Marathon plus, 24" x 1,75 "	mounted		297,20

Standard	Side cushions, removable cover, cover washable	mounted		0,00
715024	Height adapter for armpad +20 mm			21,50

713806	Cane Holder	mounted left		113,10
713812	Cane Holder	mounted right		113,10
715025	Seat belt (2250 mm)			113,10
713810	Therapy table SW 600 - 650 mm			276,50
713811	Therapy table SW 700 - 750 mm			302,40

Order form tauro|rsi

Selection	Item no.	Description	Comment	EUR*
-----------	----------	-------------	---------	------

CUSTOM MADE SOLUTIONS

932351	Addition load capacity of max. user weight up to 300 kg		on request
932352	Addition load capacity of max. user weight up to 350 kg		on request
932353	seat width < 600 mm		on request
932354	seat width > 750 mm		on request
932355	seat width > 850 mm		on request
932356	seat height > 470 mm		on request
932357	armrest height up to +60 mm		on request
932358	armrest, upholstered, 400 mm		on request
932359	foldable side parts		on request
932360	Sego comfort back		on request
932361	Infusion holder		on request

Can only be processed in conjunction with a fully completed customized production report

SERVICE

1015	Service fee for testing and documentation (not discountable)		572,00
------	--	--	--------



Product group: Manual XXL-Wheelchair
Product: tauro|rsi

DIETZ GmbH
Reutäckerstraße 12
76307 Karlsbad
info@dietz-group.de
www.dietz-group.de